

**Technical training.**  
Product information.

## **I01 Driver Assistance Systems**



**BMW Service**

Edited for the U.S. market by:  
**BMW Group University**  
**Technical Training**

ST1403a

5/1/2014

# General information

## Symbols used

The following symbol is used in this document to facilitate better comprehension or to draw attention to very important information:



---

Contains important safety information and information that needs to be observed strictly in order to guarantee the smooth operation of the system.

---

## Information status and national-market versions

BMW Group vehicles meet the requirements of the highest safety and quality standards. Changes in requirements for environmental protection, customer benefits and design render necessary continuous development of systems and components. Consequently, there may be discrepancies between the contents of this document and the vehicles available in the training course.

This document basically relates to the European version of left-hand drive vehicles. Some operating elements or components are arranged differently in right-hand drive vehicles than shown in the graphics in this document. Further differences may arise as the result of the equipment specification in specific markets or countries.

## Additional sources of information

Further information on the individual topics can be found in the following:

- Owner's Handbook
- Integrated Service Technical Application.

Contact: [conceptinfo@bmw.de](mailto:conceptinfo@bmw.de)

©2013 BMW AG, Munich

## Reprints of this publication or its parts require the written approval of BMW AG, Munich

The information contained in this document forms an integral part of the technical training of the BMW Group and is intended for the trainer and participants in the seminar. Refer to the latest relevant information systems of the BMW Group for any changes/additions to the technical data.

Information status: **July 2013**  
BV-72/Technical Training

# I01 Driver Assistance Systems

## Contents

<b>1.</b>	<b>Introduction</b>	<b>1</b>
<b>2.</b>	<b>KAFAS</b>	<b>2</b>
2.1.	Detection range	2
2.2.	Person recognition	2
2.3.	Road sign recognition	3
2.4.	Lane detection	3
2.5.	Functional limitations	5
<b>3.</b>	<b>Optional Equipment System</b>	<b>6</b>
<b>4.</b>	<b>Camera-based Collision Warning</b>	<b>7</b>
4.1.	Operation	7
4.2.	Functional principle	9
4.3.	Warning function	11
4.4.	System limits	14
4.5.	System wiring diagram	16
<b>5.</b>	<b>Road Sign Recognition</b>	<b>18</b>
5.1.	Operation	18
5.2.	System limits	18
<b>6.</b>	<b>Proactive Driving Assistant</b>	<b>21</b>
6.1.	Operation	21
6.2.	System limits	22
<b>7.</b>	<b>Reversing Camera</b>	<b>23</b>
7.1.	System components	24
7.2.	System wiring diagram	26
<b>8.</b>	<b>Park Distance Control</b>	<b>28</b>
8.1.	System components	28
8.2.	System wiring diagram	30
8.3.	Operation	31
8.4.	System limits	33
<b>9.</b>	<b>Parking Maneuvering Assistant</b>	<b>34</b>
9.1.	System components	35
9.2.	System wiring diagram	37
9.3.	Sensors	38
9.4.	Control unit	39
9.5.	Functional principle	40

# I01 Driver Assistance Systems

## Contents

9.6.	Functional prerequisites.....	41
9.7.	Operation.....	41
9.8.	System limits.....	44
<b>10.</b>	<b>Cruise Control.....</b>	<b>46</b>
10.1.	Introduction.....	46
10.2.	Cruise control with braking function.....	46
10.3.	Camera-based cruise control with Stop & Go + Active driving assistant function.....	47
10.3.1.	Control functions.....	47
10.3.2.	Operation.....	48
10.3.3.	System wiring diagram.....	51

# I01 Driver Assistance Systems

## 1. Introduction

The comprehensive package of current assist systems was adapted to the I01 and enhanced with new innovative systems to make driving a more pleasant and safer experience. The functions in the I01 are optionally available in combinations as camera-based systems by using a shared camera and corresponding control unit.

The assist systems facilitate driving of the vehicle by

- providing the driver with information
- giving the driver suggestions
- automatically intervening in the driving process.

This training reference manual contains an overview of all driver assist systems used in the I01:

- Camera-based collision warning
- Collision warning with city braking function
- Pedestrian warning with city braking function
- Speed Limit Information
- Proactive driving assistant
- Rearview camera
- Park Distance Control
- Parking maneuvering assistant
- Cruise control.



---

With the BMW I01, the majority of assist systems are only available in package combinations.

---

For more information on the operating concept of the assist systems, please refer to the operating instructions.

# I01 Driver Assistance Systems

## 2. KAFAS

The recognition of vehicles driving ahead, and the detection of objects and lane boundary markings are among the most important prerequisites to be met by assist systems. This applies not only for the far range but also the close range. The functions in the I01 are optionally available in combinations as camera-based systems using a shared camera and shared control unit.

The KAFAS camera and KAFAS control unit are main components of the following assist systems:

- Camera-based collision warning
- Collision warning with city braking function
- Pedestrian warning with city braking function
- Speed Limit Information
- Camera-based cruise control with Stop & Go function
- Traffic jam assistant.

### 2.1. Detection range

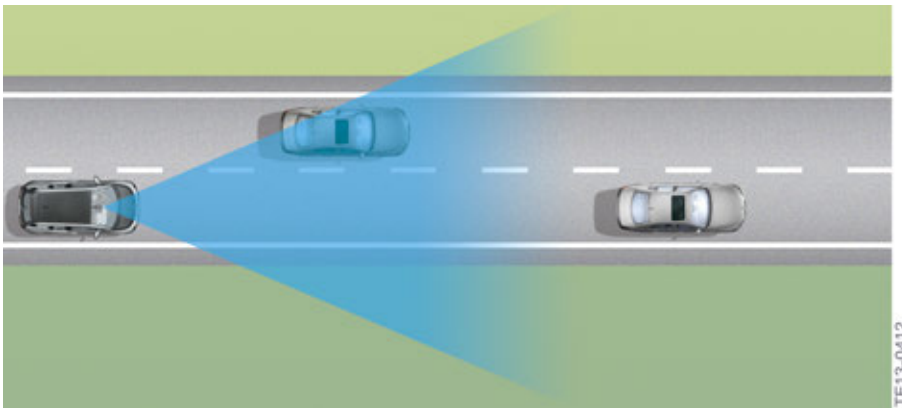

Detection range of KAFAS camera

Index	Explanation
1	Detection range of KAFAS camera

The KAFAS camera has a detection range of up to about 40 m ahead of the vehicle and up to about 5 m in front of the vehicle on the right and left.

### 2.2. Person recognition

The KAFAS camera records the scenery ahead of the vehicle and uses image processing to detect the complete rear views of moving and stationary vehicles in the field of view. The KAFAS camera also ensures that driving lane information, vehicle position and movements are determined at the same time. With the aid of the image data from the KAFAS camera, objects can be clearly identified as vehicles and corresponding transverse movements as lane changes. The KAFAS camera also detects people and cyclists.

# I01 Driver Assistance Systems

## 2. KAFAS

### 2.3. Road sign recognition

The KAFAS camera is also responsible for detecting road signs for speed limitation.

### 2.4. Lane detection

The KAFAS camera installed in the base of the interior mirror on the windshield monitors the front of the vehicle.

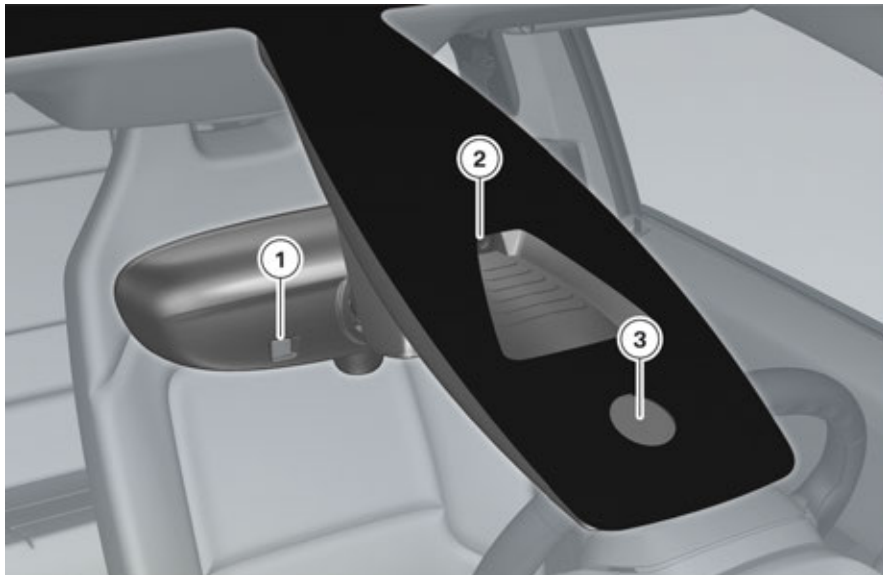

KAFAS camera

Index	Explanation
1	Photosensor for electrochromic interior mirror
2	KAFAS camera
3	Rain-light-solar-condensation sensor

The KAFAS camera records the roadway up to about 40 m ahead of the vehicle and up to about 5 m to the right and left of the vehicle. The image data is forwarded to the KAFAS control unit where it is evaluated. By means of image processing, the control unit searches the images recorded by the KAFAS camera for lane and road markings.

# I01 Driver Assistance Systems

## 2. KAFAS



KAFAS control unit

The image data acquired by the KAFAS camera is transferred to the KAFAS control unit via a LVDS data line.

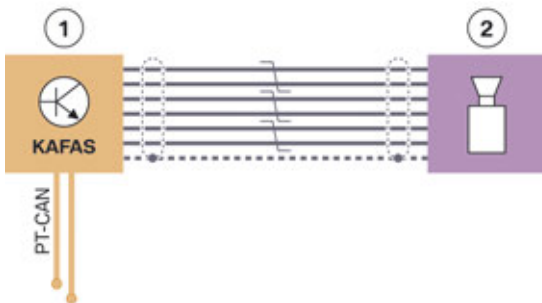

Image transmission via LVDS data line

Index	Explanation
1	KAFAS control unit
2	KAFAS camera

The appearance of the road markings and signs can vary considerably in the image depending on the country, type of road or the current ambient conditions. The system can detect a wide range of road markings and types of markings. For a lane marking to be evaluated, the KAFAS camera and the KAFAS control unit must first be able to clearly identify it. For a lane to be evaluated, its average width must be greater than 2.5 m.

The KAFAS camera and KAFAS control unit are the most important elements of the assist systems in the I01 as these are extensively camera based.



# I01 Driver Assistance Systems

## 2. KAFAS

### 2.5. Functional limitations

The function of the KAFAS camera and thus also the function of the corresponding assist systems may be impaired, due to the physical limits of the optical systems for example, in the following situations:

- heavy fog, rain or snow
- bright light in the camera lens
- if the viewing area of the KAFAS camera or the windshield is dirty
- on tight corners
- up to 10 seconds after driving readiness is activated via the START-STOP button
- during the calibration process of the KAFAS camera immediately after vehicle delivery or a camera replacement.



Example of limits of the KAFAS camera



---

System and functional limitations mean that warnings and bans may under certain circumstances not be issued or are issued too late or without authorization. The driver must therefore always remain alert and observant so that they can actively intervene at any time so as to avoid the risk of an accident.

---

# I01 Driver Assistance Systems

## 3. Optional Equipment System

The control unit for the optional equipment system (SAS) which features a large number of driver assistance functions is being used for the first time in the I01.

Possible functions:

- Camera-based collision warning
- Collision warning with city braking function
- Pedestrian warning with city braking function
- Proactive driving assistant
- Parking maneuvering assistant
- Cruise control with braking function
- Camera-based cruise control with Stop & Go function

The optional equipment system (SAS) is not part of the standard vehicle equipment and is installed depending on which optional equipment is used.

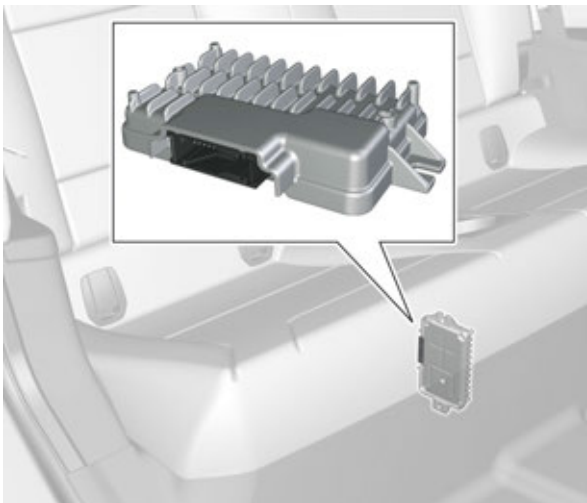

Control unit for optional equipment system (SAS)

The image data required by the optional system (SAS) is made available by the KAFAS control unit. The SAS is connected to the FlexRay, and also to the KAFAS control unit via a Local-CAN.

# I01 Driver Assistance Systems

## 4. Camera-based Collision Warning

The camera-based collision warning is an element of the optional equipment ACC Stop & Go + Active Driving Assistant (SA5AT). The collision warning warns the driver of a possible collision danger and is effected via the KAFAS camera and KAFAS control unit. The camera-based collision warning was extended in the BMW I01 to incorporate the functions collision warning with city braking function and pedestrian warning with city braking function.

The system warns the driver in situations where a collision is imminent. The early warning, a visual signal, is issued first to draw the driver's attention to the situation. If the situation becomes more critical, an acute early warning in the form of a visual and acoustic signal is issued. The nature of the warning is such that the driver can still prevent a collision providing he/she acts quickly.

### 4.1. Operation

The collision warning and pedestrian warning functions are switched on automatically when the driving readiness is activated via the START-STOP button.

#### Switching on/off

The collision warning and pedestrian warning are switched on and off via the Intelligent Safety button.



Intelligent Safety button

Index	Explanation
1	Intelligent Safety button

#### Press button:

- A menu is displayed in the Central Information Display (CID). The collision warning and pedestrian warning functions can then be selectively switched on and off. The Personal Profile is stored for the ID transmitter currently used.

# I01 Driver Assistance Systems

## 4. Camera-based Collision Warning



TE13-0793

Intelligent Safety: all systems activated

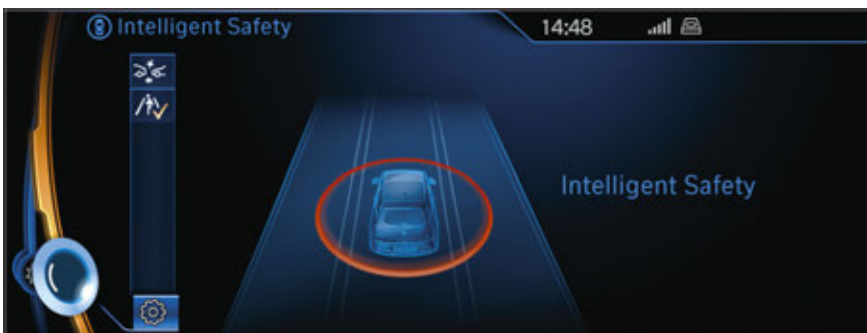

TE13-0792

Manual adjustment of Intelligent Safety: pedestrian warning deactivated

### Press button briefly:

- Intelligent Safety systems are switched off individually depending on the Personal Profile
- The LED in the Intelligent Safety button lights up orange or goes out, depending on the Personal Profile

### Press button again:

- All Intelligent Safety systems are switched on
- The LED in the Intelligent Safety button lights up green.

### Press and hold button:

- All Intelligent Safety systems are switched off
- The LED in the Intelligent Safety button goes out.

### Adjusting the warning time

When the collision warning is activated the driver can set the time of the early warning in three stages. The "late" setting corresponds to the point of the acute warning.

The setting is made via the iDrive:

# I01 Driver Assistance Systems

## 4. Camera-based Collision Warning

- "Settings"
- "Collision warning"
- Set the required warning time via the controller at the Central Information Display.

The setting for the time of the early warning is saved for the current driver profile or for the ID transmitter currently used.

### 4.2. Functional principle

The KAFAS camera records the scenery ahead of the vehicle and uses image processing to detect the complete rear views of moving and stationary vehicles in the field of view.

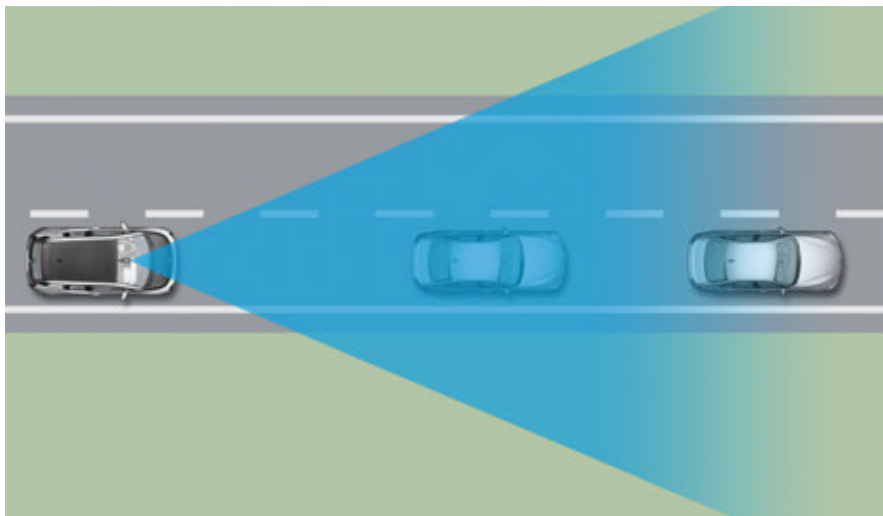

Collision warning detection range by KAFAS video camera

The corresponding warning stages "early warning" and "acute warning" are output in critical situations on the basis of the calculated positions, distances and relative speeds of other vehicles. For the early warning the brakes of the vehicle are prepared for emergency braking and the activation thresholds of the brake assistants are reduced. If the driver makes the conscious decision to drive up close to the vehicle ahead, warnings which may otherwise be distracting can be prevented by reducing the sensitivity of the system.

#### Collision warning with city braking function

The collision warning with city braking function extends the camera-based collision warning with a braking function from a speed of roughly 10 km/h / 6 mph up to a maximum speed of 60 km/h / 37 mph. If an acute warning is issued within this speed range, the vehicle is decelerated by 4 m/s<sup>2</sup> at the most.

The brake intervention is restricted to roughly 1.6 seconds. This avoids additional dangers for the following traffic.

# I01 Driver Assistance Systems

## 4. Camera-based Collision Warning

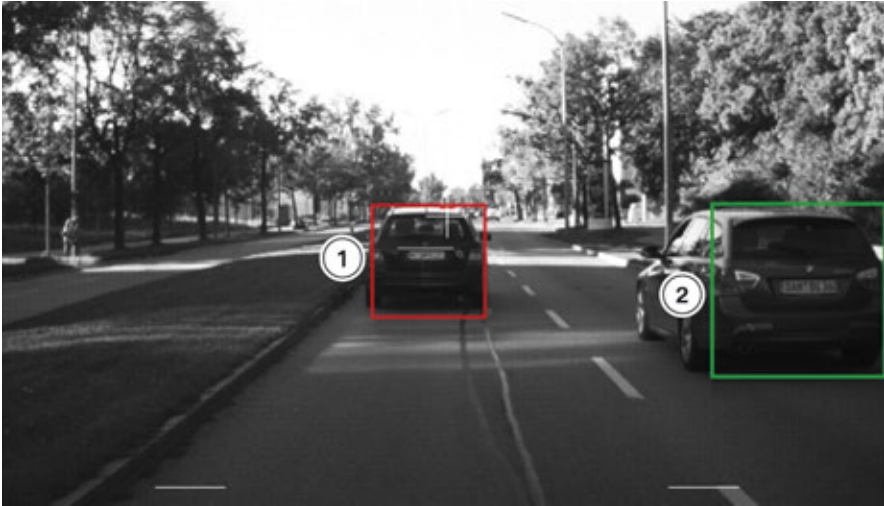

Example of vehicle identification by KAFAS camera

Index	Explanation
1	Vehicle in same lane
2	Vehicle in different lane

### Pedestrian warning with city braking function

The system provides a warning against a collision with pedestrians from a speed of roughly 10 km/h / 6 mph up to a maximum speed of 60 km/h / 37 mph .

The KAFAS camera records the scenery ahead of the vehicle and uses image processing to detect pedestrians in the field of view. An acute warning is output in critical situations on the basis of the calculated positions, distances and the movement of the identified pedestrians. An early warning is not available for the pedestrian warning with city braking function. With an acute warning the vehicle is decelerated by roughly 4 m/s<sup>2</sup>.

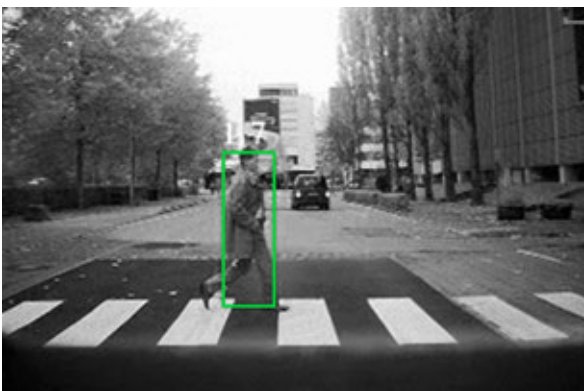

Example of person recognition by KAFAS camera

The warning zone for person recognition in front of the vehicle is subdivided into two areas. The central area (ahead of the vehicle) and the additional area (to the left and right in front of the vehicle).

# I01 Driver Assistance Systems

## 4. Camera-based Collision Warning

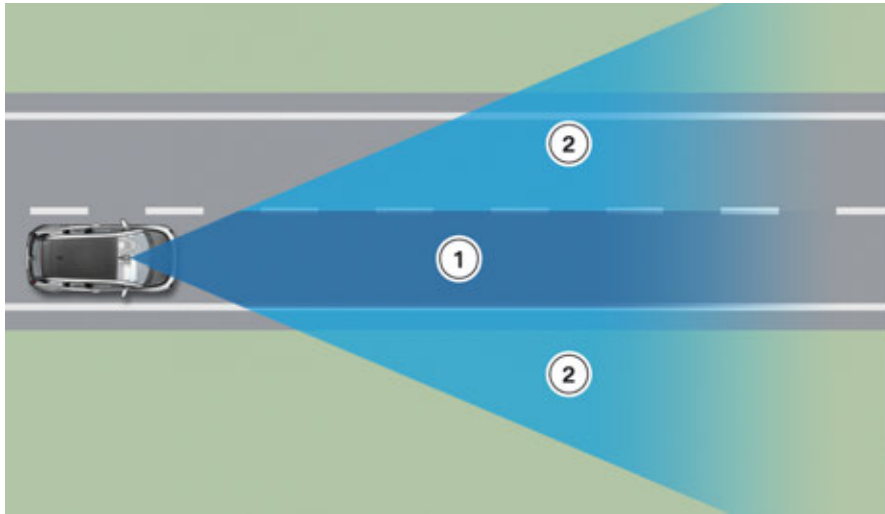

Warning zone, person recognition

Index	Explanation
1	Central area
2	Extended area

### 4.3. Warning function

The warning function is divided into two stages. If there is a danger of collision, a warning symbol is displayed at the instrument cluster.

#### Display



#### Early warning:

- Vehicle symbol lights up red
- Text message: Increase distance and, if necessary, brake.



#### Acute warning:

- Vehicle symbol flashes red and a signal sounds
- Text message: Request for intervention by braking and, if required, evasive action.

# I01 Driver Assistance Systems

## 4. Camera-based Collision Warning



Acute warning:

- Person symbol flashes red and a signal sounds
- Text message: Request for intervention by braking and, if required, evasive action.

### Early warning

The early warning is issued, for example, if there is a danger of collision because the vehicle driving ahead is being driven at a much slower speed and/or if the distance to a driven or stationary vehicle ahead is extremely short.

The early warning is indicated by a vehicle symbol which lights up red in the instrument cluster.

The time of the early warning can be configured in the CID.



The collision warning is dependent on the vehicle's inherent driving speed. The distance calculated for the collision warning is much lower than the minimum distance required by law. It is therefore still the driver's responsibility to maintain the legal minimum distance.

### Acute warning

The acute warning is issued by the system as late as possible and only if there is an imminent danger of a collision when the vehicle is approaching the vehicle driving ahead at a relatively high differential speed or if there is an imminent danger of a collision with a pedestrian. The point at which the acute warning is issued is calculated in such a way that a collision can only be avoided by immediate emergency braking or by an evasive manoeuvre. The acute warning therefore cannot be deliberately brought about or monitored by the driver.

If the vehicle is for example approaching the vehicle driving ahead at very low speed, or is approaching a person, an acute warning is not issued even when the distance is very small. This deliberately brought-about driving situation merely triggers off the early warning. In this way, less sensible and thus more annoying acute warnings are avoided by the system.

The acute warning cannot be deactivated. The timing of the acute warning also cannot be adjusted. If the acute warning is not to be issued, the "collision warning" front protective function must be deactivated.

The acute warning issues a prompt for intervention and is supported if there is a danger of collision by a two-stage intervention. Once the driver has been warned of the danger of collision, brake preconditioning initially takes place followed by the initiation of automatic brake intervention to avert the collision danger.

The brake intervention is restricted to roughly 1.6 seconds. This avoids additional dangers for the following traffic.

Once the target object has been verified by the camera data braking intervention takes place at roughly  $4 \text{ m/s}^2$ . This achieves a speed reduction of up to approx. 16 km/h. In the bottom speed range braking up to a standstill is therefore entirely possible.



# I01 Driver Assistance Systems

## 4. Camera-based Collision Warning

In the speed range of 10 km/h / 6 mph to 60 km/h / 37 mph , brake intervention is applied at a brake force of roughly 4 m/s<sup>2</sup> when collision with a pedestrian is detected.

Brake intervention also takes place if the driver fails to press the brake pedal sufficiently.

Brake intervention is applied only when Dynamic Stability Control (DSC) is switched on.

In the event of an acute warning, a red flashing vehicle symbol or a red flashing person symbol is displayed for the driver at the instrument cluster. In addition, an acoustic warning signal is sounded.



---

The acute warning does not relieve the driver of their responsibility to adapt their driving speed and driving style to the road and traffic conditions and to maintain the prescribed safety distance.

---

Brake intervention can be cancelled by pressing the accelerator pedal or by applying a clear steering wheel movement.

The braking function is deactivated when Dynamic Stability Control (DSC) or Dynamic Traction Control (DTC) is deactivated.

### Chronological sequence

The timescale of the warnings and the braking is shown in the following graphic. There is no brake intervention if an avoidance by the driver is recognized.

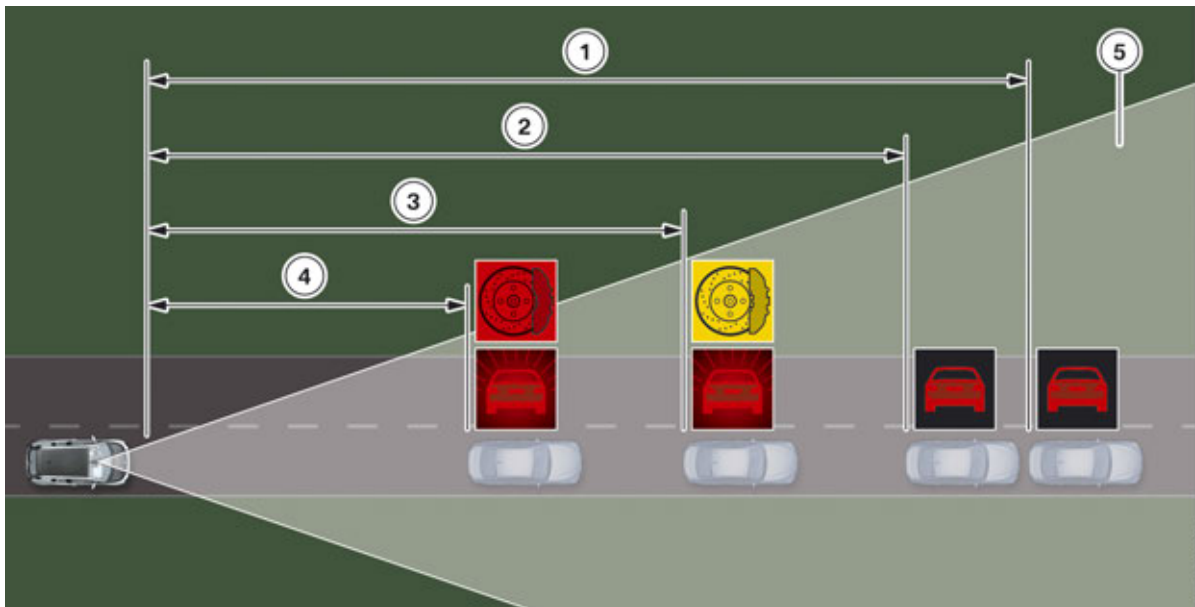

Timescale of camera-based collision warning

# I01 Driver Assistance Systems

## 4. Camera-based Collision Warning

---

Index	Explanation
1	Collision warning (early)
2	Collision warning (late)
3	Acute warning (acoustic warning signal, brake system is prepared and brake assistant is adapted)
4	Braking at roughly 4 m/s <sup>2</sup> is introduced (city braking function only in the approximate range of roughly 10 to 60 km/h, 6 to 37 mph)
5	Detection range of KAFAS camera

### 4.4. System limits

#### Range of detection



---

The collision warning has a limited capacity for detection. This means that warnings sometime may not be issued or may be issued late.

The following vehicles may possibly not be detected:

- A vehicle traveling at slow speed when approaching at high speed
- Vehicles that cut in suddenly or are heavily decelerating
- Vehicles with an unusual rear view or with poorly visible rear lights
- Partially concealed vehicles
- Two-wheeled vehicles traveling ahead.

---

#### Functional limitations

The function of the KAFAS camera and thus also the function of the corresponding assist systems may be impaired in the following situations, for example:

- heavy fog, rain or snow
- insufficient daylight
- bright light in the camera lens
- if the viewing area of the KAFAS video camera or the windshield is dirty
- on sharp curves
- with persons up to approx. 80 cm in height.
- up to 10 seconds after an engine start via the START-STOP button
- during the calibration process of the KAFAS video camera immediately after vehicle delivery or a camera replacement.

# I01 Driver Assistance Systems

## 4. Camera-based Collision Warning



---

System limitations mean that warnings may under certain circumstances not be issued or are issued too late or without authorisation. The driver must therefore always remain alert and observant so that they can actively intervene at any time so as to avoid the risk of an accident.

---

# I01 Driver Assistance Systems

## 4. Camera-based Collision Warning

### 4.5. System wiring diagram

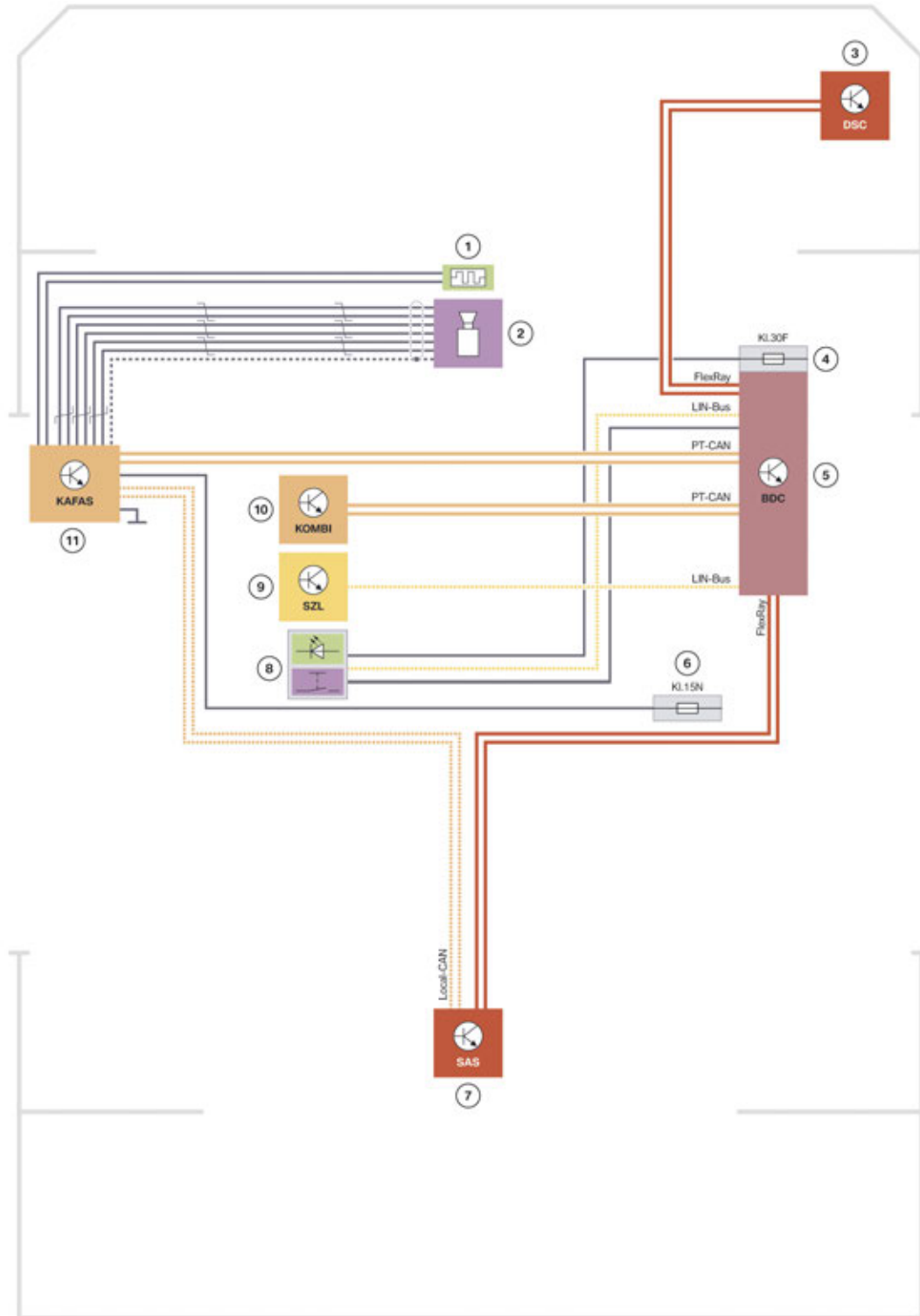

TE13-0646

System wiring diagram for camera-based collision warning

# I01 Driver Assistance Systems

## 4. Camera-based Collision Warning

<b>Index</b>	<b>Explanation</b>
1	Heating KAFAS camera
2	KAFAS camera
3	Dynamic Stability Control
4	Fuse
5	Body Domain Controller
6	Fuse
7	Optional equipment system (SAS)
8	Intelligent Safety button
9	Steering column switch cluster
10	Instrument cluster
11	KAFAS control unit

# I01 Driver Assistance Systems

## 5. Road Sign Recognition

The road sign recognition displays a road sign symbol in the instrument cluster which shows the maximum speed limit currently detected. The KAFAS camera detects road signs at the edge of the road. The optional equipment road sign recognition is an element of the optional equipment ACC Stop & Go + Active Driving Assistant (SA 5AT).



---

Responsibility for the vehicle and for the speed that is adopted rests exclusively with the driver.

---

### 5.1. Operation

The road sign recognition can be switched on and off in the iDrive menu by making the following selection via the controller:

- Settings
- KOMBI
- Speed Limit Info

If the road sign recognition is switched on, this is displayed at the KOMBI in the instrument cluster. If a speed limit symbol with three horizontal dashes is displayed in the instrument cluster instead of the max. permissible speed, the road sign recognition is not available.

### 5.2. System limits

The system has a detection rate of around 90 to 95%.

Traffic signs for top speed limitations that do not comply with the legal standard, particularly those without square frames, are not always detected. The same applies to road signs which are fully or partially concealed by stickers, dirt or vegetation. Long distances to the road sign, high driving speeds and poor weather conditions, particularly at night, make it more difficult for the system to recognize road signs reliably. To ensure the current top speed limitations are displayed as accurately as possible, the data of the navigation road map should be up-to-date.

The functionality of the road sign display may be limited, e.g. in the following situations, which can lead to an incorrect display:

- heavy fog, rain or snow
- if signs are covered by objects
- if driving at close proximity to a vehicle driving ahead
- strong light in the camera lens
- if the windshield in front of the interior mirror is fogged, dirty or covered by labels, etc.
- as a result of incorrect detection by the camera
- if the top speed limitations stored in the navigation system are incorrect
- in areas not covered by the navigation system

# I01 Driver Assistance Systems

## 5. Road Sign Recognition

- in the event of deviations from the navigation, e.g. due to modified road layouts
- if traffic signs do not correspond to the standard
- when calibrating the camera immediately after vehicle delivery.

### **Supplementary sign recognition**

The system can only recognize supplementary signs with pictograms (icons), such as e.g. "In wet conditions", "In rain/snow conditions", "Trucks" or "Trailers". Text references to supplementary signs basically cannot be read or interpreted.

Before top speed limitations with a limited applicability are displayed, the system checks the vehicle electrical system for more information. Thus, with the validity "In wet conditions" the status of the windscreen wiper is evaluated or with the validity "In frost/snow conditions" the temperature value from the outside temperature sensor is evaluated.

The time limits of the top speed limitation can then only be evaluated correctly if the period of validity is stored in the navigation map and the clock in the vehicle is set correctly. Otherwise the top speed limitation or ban on passing/overtaking is displayed as currently valid.

The trailer signal for vehicles in towing mode is not evaluated for the display of top speed limitations, as they differ from country to country and depend on the trailer type.

Other supplementary road signs are not recognized. The top speed limitation is then displayed as valid and up-to-date without the interpretation of the supplementary road sign.

### **Road signs on parallel, branching-off or merging roads and on exits**

Parallel roads are recognized neither with the KAFAS camera nor with the aid of the navigation map. Signs erected there could be incorrectly recognized and displayed as top speed limitation for the road currently being driven on.

Top speed limitations for branching-off or merging roads are usually also adopted and displayed for the road currently being driven on.

Top speed limitations on motorway exits with or without an additional arrow sign are usually correctly evaluated and suppressed in the display when the exit is passed providing the navigation map data is up-to-date.

In the case of overhead motorway signs with different, lane-specific top speed limitations, the top speed limitation nearest to the lane in which the vehicle is driving in is displayed. The display is not modified after a later lane change.

### **Information signs in the road sign surroundings**

Information signs with top speed limitations, e.g. at border crossings with references to the different legal maximum speeds for ordinary roads and highways, can be mistakenly recognized as currently valid and displayed. The same applies to information signs with different color configurations, e.g. for minimum or recommended speeds.

### **Stickers on vehicles**

Stickers on vehicles driving ahead or overtaken vehicles indicating a top speed limitation, e.g. trucks, buses, trailers and construction machinery, could be mistakenly recognized and displayed as the currently valid top speed limitation.

# I01 Driver Assistance Systems

## 5. Road Sign Recognition

### **Town/city limits**

If the town/city limits sign is not clearly recognized and the data in the navigation map is not up-to-date, the top speed limitation at town/city limits may be incorrectly displayed.

### **Legal changes**

If maximum speeds prescribed by law are changed, these are only available after a software update. The original speed limits which no longer apply continue to be displayed until the software is updated.



---

The system cannot replace the driver's personal assessment of the road and traffic situation. System and functional limitations mean that warnings and bans may under certain circumstances not be issued or are issued too late or without authorisation. Road sign recognition supports the driver and does not replace the human eye.

---



# I01 Driver Assistance Systems

## 6. Proactive Driving Assistant

This proactive driving assistant detects bends, entrances to towns, roundabouts, intersections, junctions, speed limits and highway exits using the data from the navigation system and can suggest at an early stage that the driver should take his foot off the accelerator pedal. A message is also issued if the section of road ahead has not yet been detected. This information is displayed in the instrument cluster until the road section is reached. The proactive driving assistant helps drivers who are not familiar with the route or area to drive more efficiently.

### Display in the instrument cluster

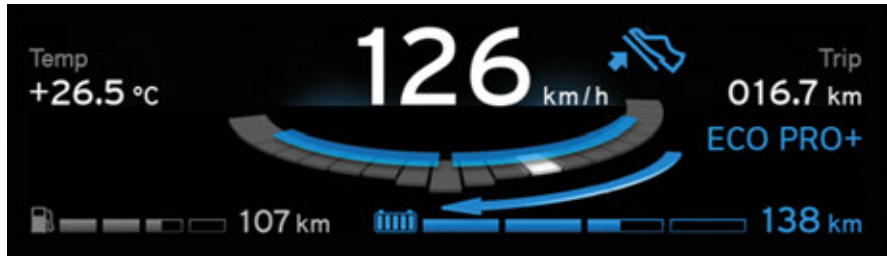

Proactive driving assistant symbol

### 6.1. Operation

To use the proactive driving assistant, ECO PRO mode or ECO PRO+ mode must be activated via the driving experience switch.



Switch block with driving experience switch

Index	Explanation
1	Driving experience switch

The proactive driving assistant can be used when the route guidance is active and inactive. When the route guidance is not active, the most likely route is used for evaluation. However, the calculation can be performed more accurately, and therefore more efficiently, when the route guidance is active.

# I01 Driver Assistance Systems

## 6. Proactive Driving Assistant



---

The reliability of the system depends on the version and quality of the navigation data.

---

### 6.2. System limits

The proactive driving assistant is not available in the following situations:

- Speed below 50 kph / 31 mph
- Temporary and variable top speed limitation, e.g. on construction sites
- Quality of navigation data
- Cruise control active.

# I01 Driver Assistance Systems

## 7. Reversing Camera

The rear view camera is only available in conjunction with the parking assistance package (SA 5DU) included in the Parking Package ZPK and provides the driver with additional support when entering/exiting parking spaces and when maneuvering.



Rear view camera, view in CID

The image from the reversing camera is displayed with additional extension lines in the Central Information Display. The display help lines function can be switched on and off by the driver via the controller.

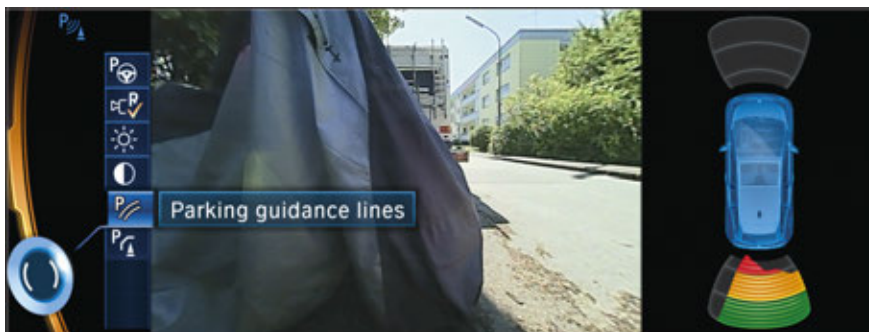

Rear view camera, view in CID, setting parking assistance lines



Rear view camera, view in CID with parking assistance lines

The obstruction marking provides the driver with further assistance. This can also be switched on and off in iDrive.

# I01 Driver Assistance Systems

## 7. Reversing Camera



Rear view camera, view in CID, setting obstruction marking

TE13-0789



Rear view camera, view in CID with parking assistance lines and obstruction marking

TE13-0790

### 7.1. System components

The control unit for the Top Rear Side View Camera (TRSVC control unit) is integrated into the housing of the rear view camera. Side View and Top View cameras are not available with the I01.



Control unit of rear view camera

TE12-1047

The new camera must be taught in after the reversing camera is replaced. The reversing camera of the I01 does not need to be calibrated after teaching-in, as it is self-calibrating. The calibration is carried out during driving by the TRSVC control unit by means of a steering angle sensor and known road markings. Installation tolerances are done by shifting and rotating the image during calibration. The maximum time required for a full calibration is five hours. A Check Control message is displayed in the

# I01 Driver Assistance Systems

## 7. Reversing Camera

CID if the reversing camera could not be successfully calibrated. Reasons for failed calibration may be incorrect installation, dirt contamination or a defect with the reversing camera. The reversing camera is also constantly readjusted after a full calibration in order to ensure an optimum image.

The opening angle of the reversing camera's lens is 130°.

# I01 Driver Assistance Systems

## 7. Reversing Camera

### 7.2. System wiring diagram

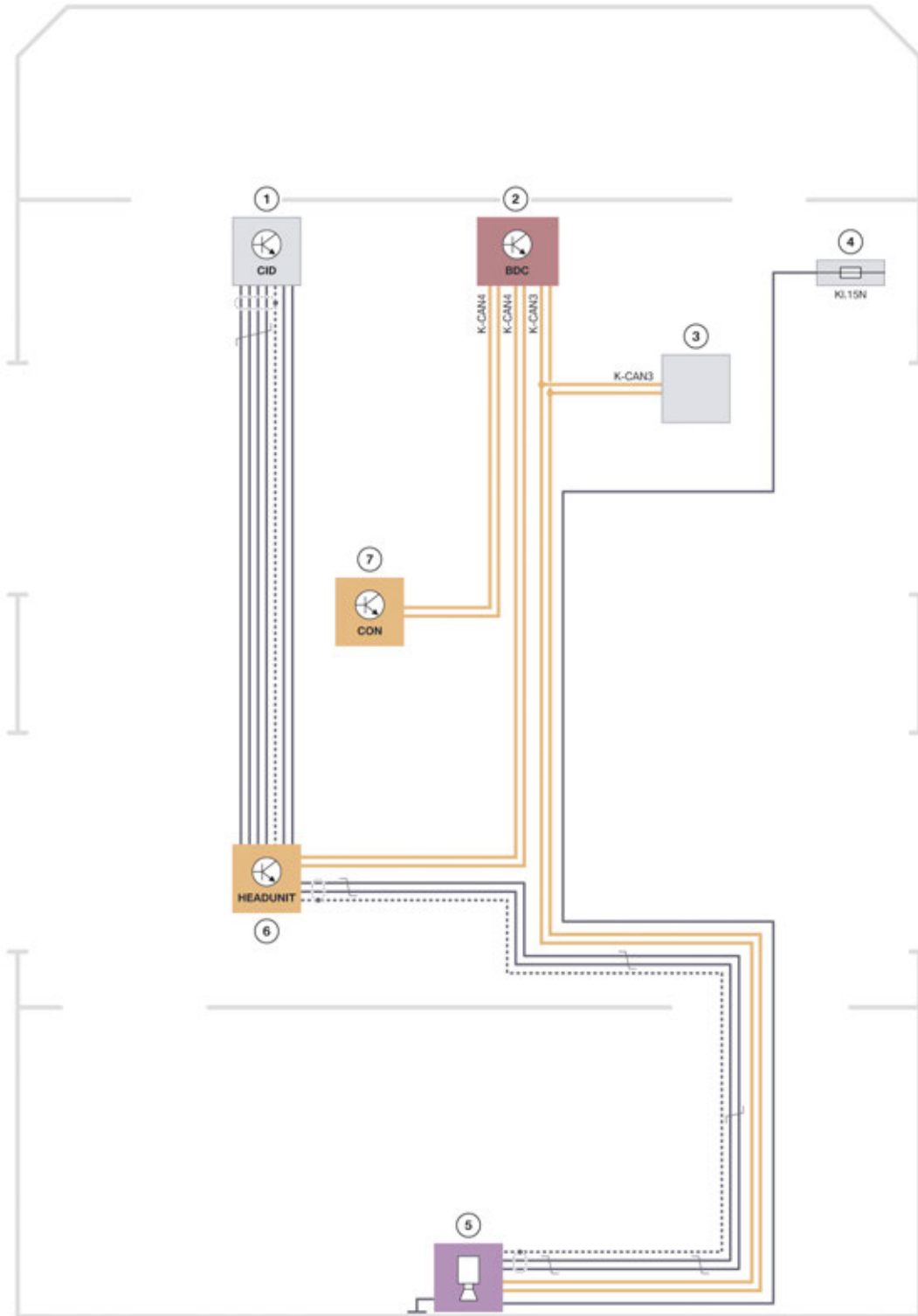

TE13-0428

System wiring diagram, reversing camera

# I01 Driver Assistance Systems

## 7. Reversing Camera

<b>Index</b>	<b>Explanation</b>
1	Central information display
2	Body Domain Controller
3	CAN-Terminator
4	Fuse
5	Rear view camera with integrated TRSVC control unit
6	Head unit
7	Controller

# I01 Driver Assistance Systems

## 8. Park Distance Control

Park Distance Control (PDC) assists the driver when maneuvering in and out of a parking space.

The front and rear Park Distance Control (SA 508) is included in the optional Parking Package (ZPK) in the I01. .

The distance between the vehicle and obstacle is measured by four ultrasonic sensors in the rear bumper and, in vehicles with Park Distance Control, four additional ultrasonic sensors are also incorporated into the front bumper.

### 8.1. System components

The PMA control unit is used instead of the PDC control unit in vehicles with the optional equipment Parking Maneuvering Assistant. The PMA control unit is exactly the same dimensions and installation position as the PDC control unit. Compared to the PDC control unit, the PMA control unit has a more powerful processor and software.

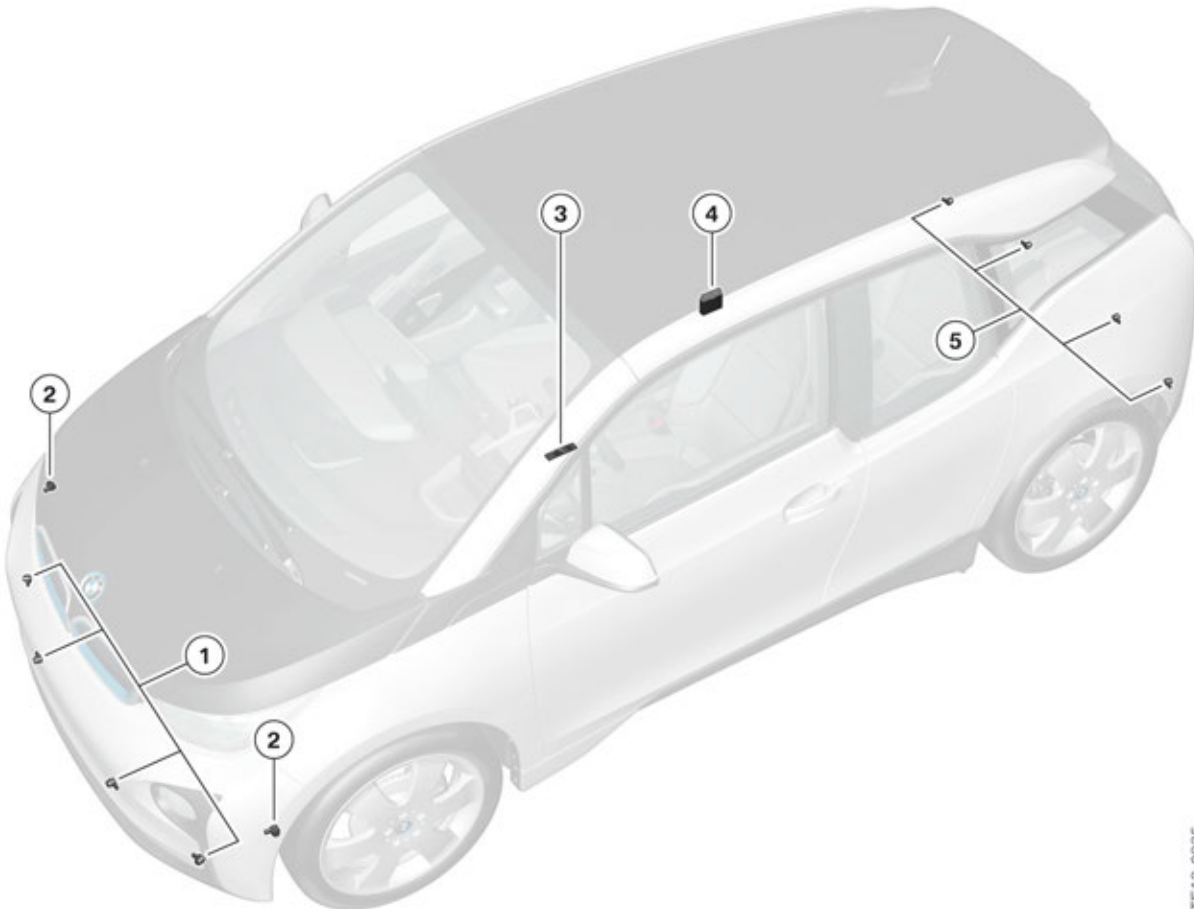

TE13-0935

Park Distance Control system components



# I01 Driver Assistance Systems

## 8. Park Distance Control

<b>Index</b>	<b>Explanation</b>
1	Front ultrasonic sensors, only installed with optional equipment Parking Package (SA ZPK)
2	Parking Maneuvering Assistant ultrasonic sensors, only installed with optional equipment Parking Package (SA ZPK)
3	Operating facility
4	Park Distance Control control unit
5	Ultrasonic sensors, rear

# I01 Driver Assistance Systems

## 8. Park Distance Control

### 8.2. System wiring diagram

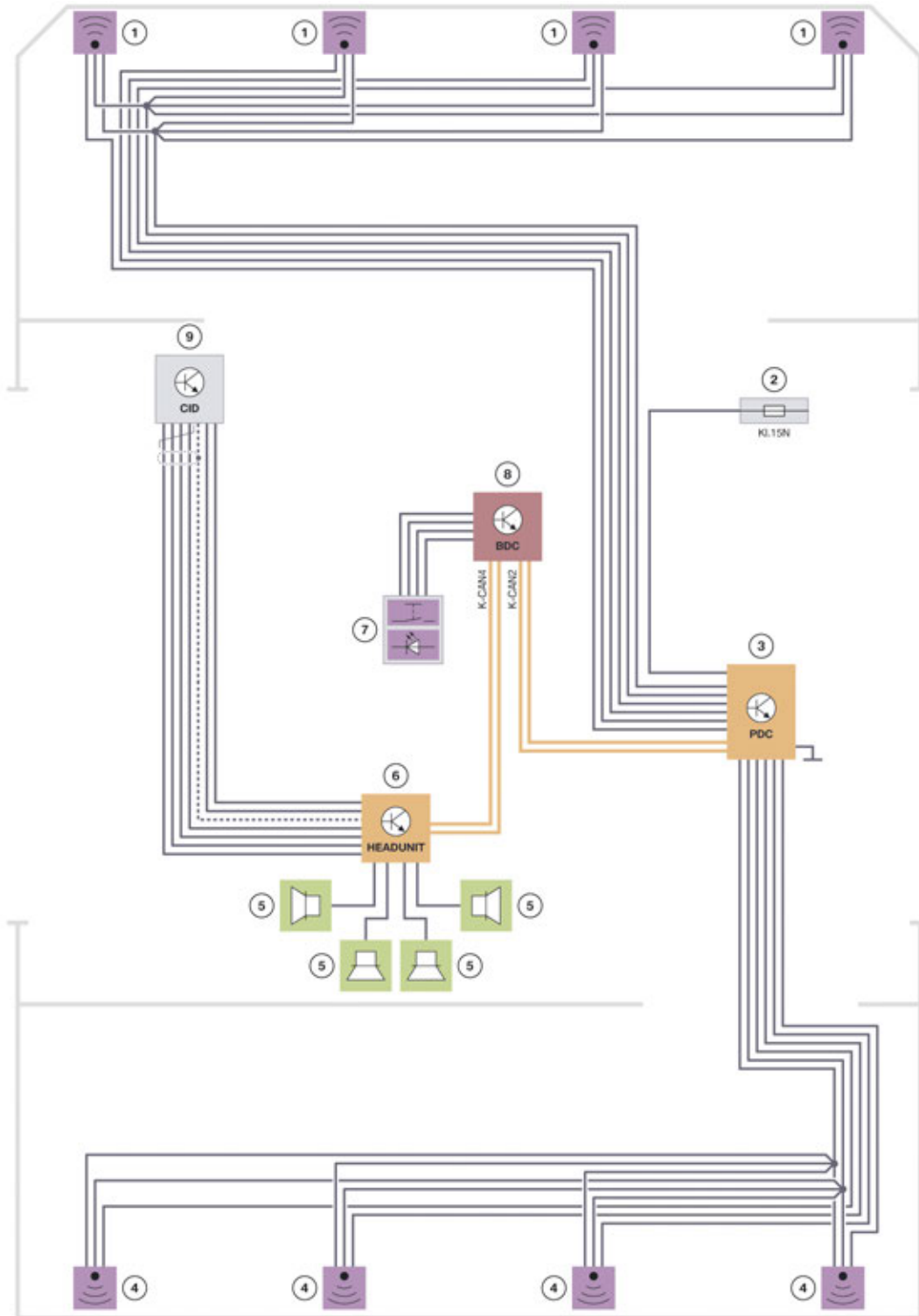

TE13-0121

Park Distance Control system wiring diagram

# I01 Driver Assistance Systems

## 8. Park Distance Control

Index	Explanation
1	Ultrasonic sensors, Park Distance Control, front
2	Fuse
3	Park Distance Control control unit
4	Ultrasonic sensors, Park Distance Control, rear
5	Vehicle speaker
6	Head unit
7	Operating facility
8	Body Domain Controller
9	Central information display

### 8.3. Operation

The Park Distance Control system is enabled in the following situations:

- if drive position R is engaged when driving readiness is switched on
- if the parking assistance button in the switch block next to the iDrive is pressed when driving readiness is switched on
- the activation takes place automatically if the vehicle is equipped with the optional equipment Parking Package (SA ZPK) and obstacles behind or in front of the vehicle are detected by the Park Distance Control and the vehicle is traveling at less than approx. 3 km/h / 1 mph.



Switch block with parking assistance button

Index	Explanation
1	Parking assistance button

# I01 Driver Assistance Systems

## 8. Park Distance Control

With Park Distance Control system (SA 508) which is included in the optional Parking Package ZPK, activation only takes place when the drive position "R" is engaged. A parking assistance button is not installed with this configuration.

The automatic activation of the PDC system is implemented in combination with the optional equipment Parking Package (SA ZPK). The automatic activation which takes place when obstacles are detected can be switched on and off via the controller in the "Settings" menu. The settings are stored for the ID transmitter which is currently being used.



Automatic Park Distance Control



Automatic activation of the PDC system by the Auto PDC is only possible within a speed range of less than 3 km/h.



If Auto PDC was active and was switched off via the PDC button, the speed threshold of 5 km/h / 3 mph must have been exceeded once for the Auto PDC to be operational once again.

The driver is notified about the results of the distance measurements and the distance warnings acoustically via the audio speakers and optically via the Central Information Display CID. As the vehicle approaches an object, the corresponding position is indicated by an intermittent tone via the audio speaker. If, for example, an object is detected behind the vehicle to the left, the rear left speaker emits an acoustic signal. A continuous alarm sounds when the object is at a distance of about 25 cm or less. The volume of the acoustic signal of the Park Distance Control system can be adjusted in relation to the audio playback of the entertainment system.



Park Distance Control volume balancing

### Deactivation criteria

# I01 Driver Assistance Systems

## 8. Park Distance Control

Similar to other BMW models, the deactivation is distance/speed based. It is switched off after driving of about 50 m or at speeds in excess of 36 km/h / 22 mph.

If a fault develops, a Check Control message ("PDC has malfunctioned. Have system checked.") is displayed in the Central Information Display CID. In addition, the detection range of the sensors is shown shaded in the Central Information Display CID.

### 8.4. System limits

Due to the physical limits during the ultrasonic measurement, obstructions may not be detected by the Park Distance Control system. Several examples of this are shown below:

- when the objects are thin or wedge-shaped
- when the objects are low
- when objects that, due to their shape, have corners and sharp edges
- with snow
- if the objects have a porous surface.

A warning may also be displayed although there is no obstruction in the detection range; in the following situations for example:

- when it is raining heavily
- if the sensors are heavily soiled or iced over
- if the sensors are covered with snow
- if the street surface is rough
- if the road surface is bumpy, e.g. speed bumps
- due to heavy exhaust gas fumes
- due to other ultrasound sources.

To ensure the ultrasonic sensors remain fully operational, they must be kept clean and free of ice. When cleaning the sensors using a high pressure cleaner, avoid direct and sustained contact with a high-pressure water jet. Furthermore, when using high pressure cleaners, a distance of at least 30 cm from the sensors must be maintained.



---

The Park Distance Control cannot replace the driver's personal judgement of the traffic situation. Also check the traffic situation by taking a look around the vehicle. Otherwise there is a risk of accidents occurring, due to other road users or objects that are outside the detection range of the Park Distance Control for example. Loud sound sources outside and inside the vehicle could drown out the PDC signal.

---

# I01 Driver Assistance Systems

## 9. Parking Maneuvering Assistant

The Parking Maneuvering Assistant (PMA) supports the driver in many ways. The assistant measures the size of a gap between cars and decides based on the result whether the gap is large enough on the one hand and relieves the driver of the task of maneuvering into the space on the other. The Parking Maneuvering Assistant (SA 5DP) is used in the I01 as optional equipment and can only be ordered in conjunction with the Parking Package (SA ZPK).

The Parking Maneuvering Assistant (PMA) has one additional function with the BMW I01. In the I01 the Parking Maneuvering Assistant (PMA) can now in addition to steering also perform the acceleration, braking and gear changing when parking parallel to and at the side of the road.

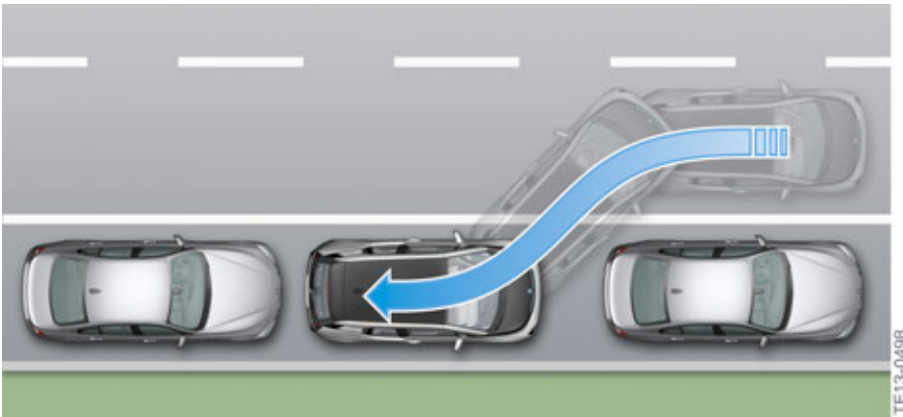

Principle of Parking Maneuvering Assistant

# I01 Driver Assistance Systems

## 9. Parking Maneuvering Assistant

### 9.1. System components

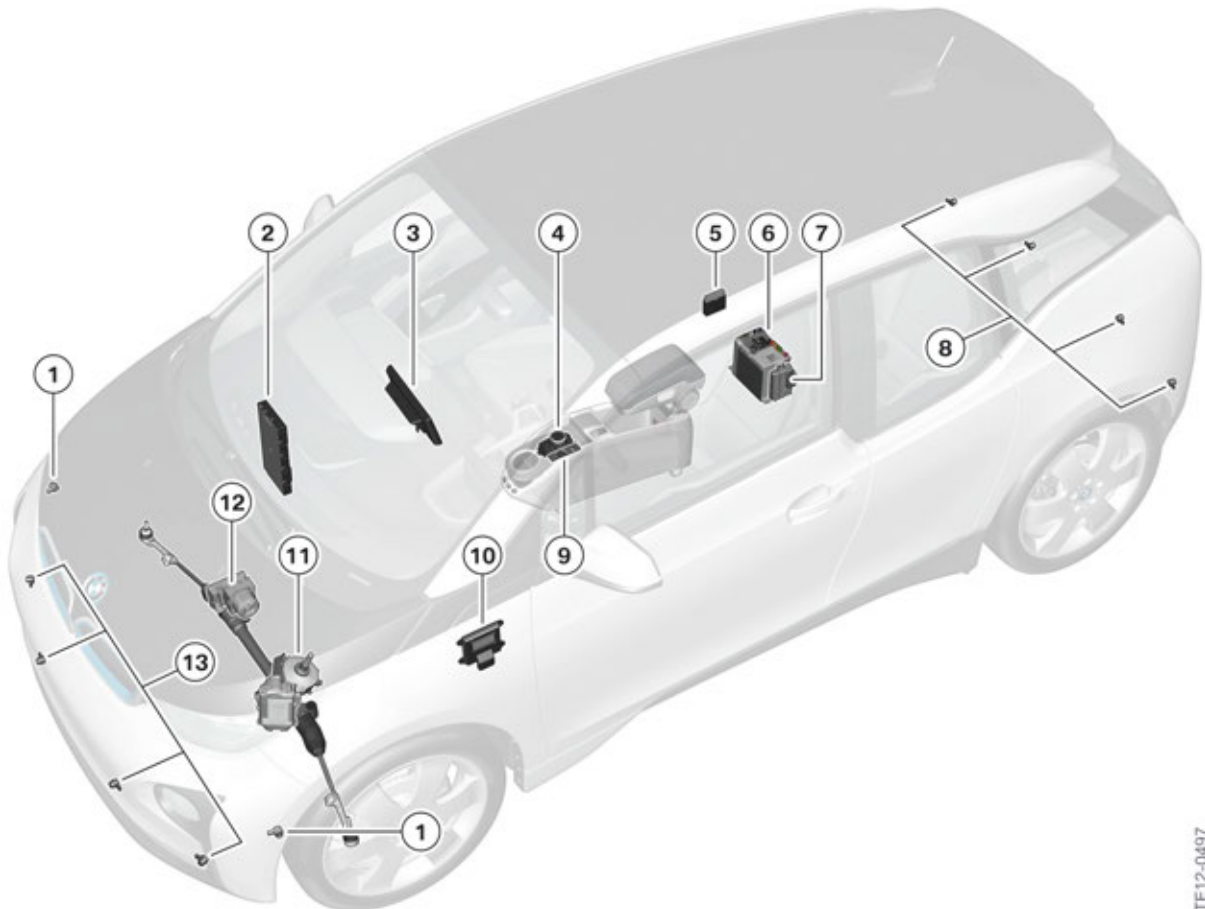

TE12-0497

System components of Parking Maneuvering Assistant

Index	Explanation
1	Ultrasonic sensors of Parking Maneuvering Assistant
2	Body Domain Controller
3	Central information display
4	Controller
5	Parking Maneuvering Assistant control unit
6	Head unit
7	Optional equipment system (SAS)
8	Ultrasonic sensors, Park Distance Control, rear
9	Operating facility, parking assistance button (switch block in center console)

# I01 Driver Assistance Systems

## 9. Parking Maneuvering Assistant

<b>Index</b>	<b>Explanation</b>
10	Electrical Digital Motor Electronics
11	Electronic Power Steering
12	Dynamic Stability Control
13	Ultrasonic sensors, Park Distance Control, front



# I01 Driver Assistance Systems

## 9. Parking Maneuvering Assistant

### 9.2. System wiring diagram

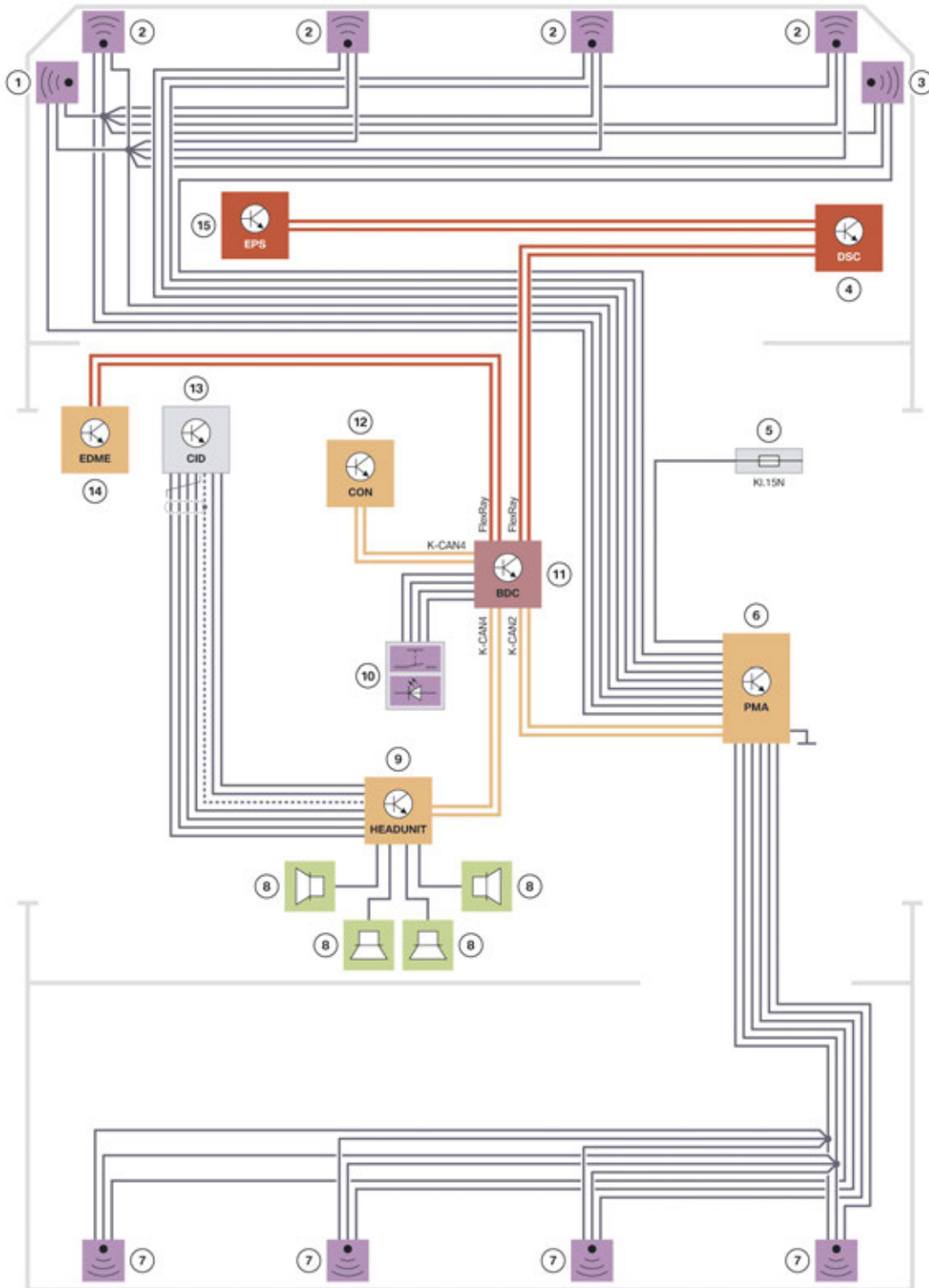

System wiring diagram for Parking Maneuvering Assistant

TE13-0211

# I01 Driver Assistance Systems

## 9. Parking Maneuvering Assistant

Index	Explanation
1	Ultrasonic sensor, Parking Maneuvering Assistant left
2	Ultrasonic sensors, Park Distance Control, front
3	Ultrasonic sensor, Parking Maneuvering Assistant right
4	Dynamic Stability Control
5	Fuse
6	Parking Maneuvering Assistant control unit
7	Ultrasonic sensors, Park Distance Control, rear
8	Vehicle speaker
9	Head unit
10	Operating unit, parking assistance button
11	Body Domain Controller
12	Controller
13	Central information display
14	Electrical Digital Motor Electronics
15	Electromechanical Power Steering

### 9.3. Sensors

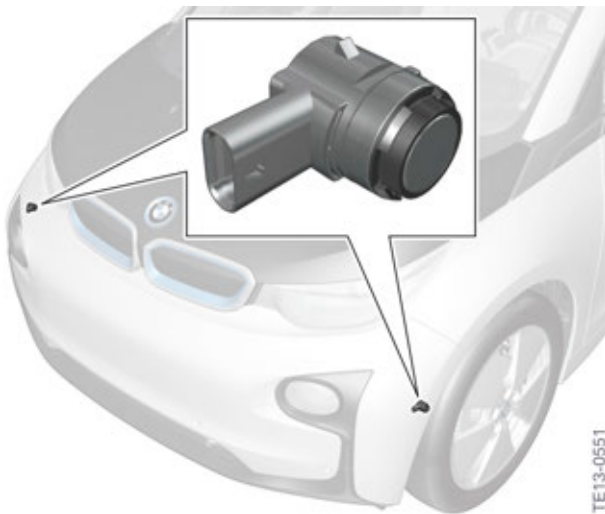

Installation location, ultrasonic sensors of Parking Maneuvering Assistant

The gaps between cars are measured via two additional ultrasonic sensors which are integrated into the front wheel arch. These two sensors are connected to the control unit of the Parking Maneuvering Assistant (PMA) which also incorporates the PDC function. The function of the two ultrasonic sensors is similar to that of the PDC. Ultrasonic pulses are transmitted and echo signals are received.

# I01 Driver Assistance Systems

## 9. Parking Maneuvering Assistant

### 9.4. Control unit

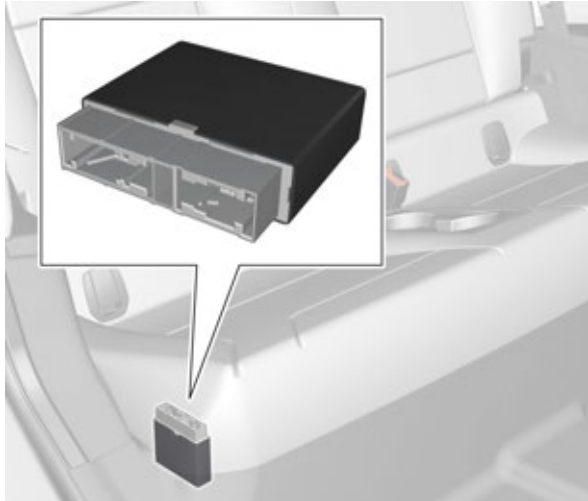

Installation location, control unit of Parking Maneuvering Assistant

The Parking Maneuvering Assistant (PMA) control unit evaluates the signals from the ultrasonic sensors and calculates the length and width of a gap between cars using the distance information from the Dynamic Stability Control. Furthermore, it evaluates the signals from the sensors and thus identifies possible parking spaces. It also calculates the optimum path into a parking space, monitors the parking process and controls the electromechanical steering.

The main unit of the function is integrated into the SAS, from where the longitudinal control, the displays in the headunit, the brake and electric motor are activated, and the lateral guidance in the PMA is enabled.

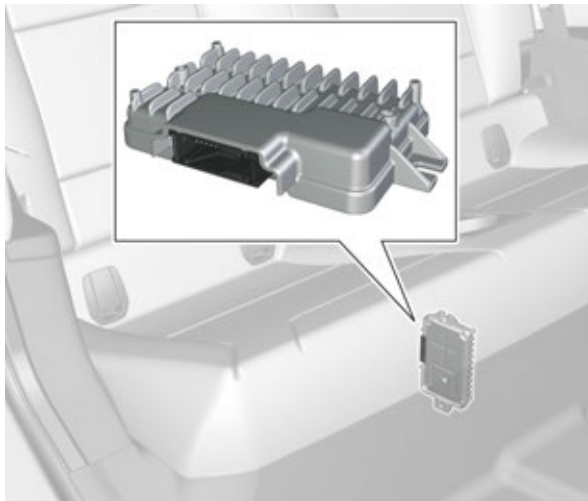

Control unit optional equipment system (SAS)

# I01 Driver Assistance Systems

## 9. Parking Maneuvering Assistant

### 9.5. Functional principle

The Parking Maneuvering Assistant facilitates parking in gaps between cars parallel to the roadway. When driving forwards straight ahead up to speeds of roughly 35 km/h / 22 mph, parking spaces are measured irrespective of whether the Parking Maneuvering Assistant is activated or deactivated. If a gap that is the same length as the vehicle plus approx. 1.2 m has been found and if the system is already activated, this gap is displayed to the driver. The ultrasonic sensors of the PMA measure parking spaces on both sides of the vehicle and parking spaces that have been detected are displayed to the driver in the CID.

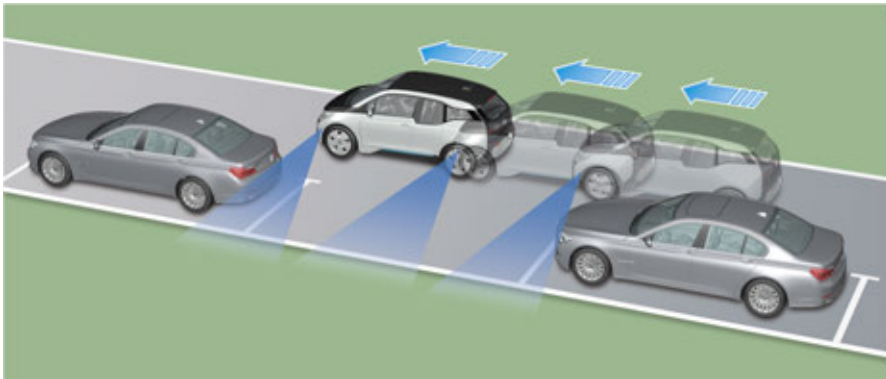

Measurement of the gap

The PMA calculates the optimum parking line and subsequently undertakes the complete vehicle guidance with steering, braking and changing drive position. Gear P is engaged at the end of the parking operation.

The driver is still responsible for monitoring the vehicle environment and can intervene in the automatic parking manoeuvre at any time if required due to the vehicle environment. When searching for a parking space and when parking, all relevant information is presented to the driver in an integrated display; from the parking space itself to the status of the parking assistant and corresponding handling instructions through to distances from other objects.

#### Personal responsibility:

- Directly monitor the parking space and parking procedure and intervene if necessary, as otherwise an accident may occur
- If a parking space that has already been measured changes, the system does not take this into account
- The system does not take loads that project beyond the vehicle into account during parking
- The PMA may steer the vehicle over or up onto curbs. You should therefore use the facility for active intervention at any time with caution as you may otherwise damage wheels and tires or the vehicle itself.



---

The Parking Maneuvering Assistant (PMA) does not relieve the driver of personal responsibility during parking. The driver must therefore always remain alert and observant so that they can actively intervene at any time so as to avoid the risk of an accident.

---

# I01 Driver Assistance Systems

## 9. Parking Maneuvering Assistant

### 9.6. Functional prerequisites

#### Measuring parking spaces

- Driving forwards straight-ahead up to approx. 35 km/h / 22 mph
- Maximum distance to the row of parked vehicles: 1.5 m

#### Suitable parking spaces

- Minimum length of space: own vehicle length plus approx. 1.2 m
- Minimum depth: approx. 1.5 m.

#### Parking procedure

- Closed doors
- Automatic Hold brake released
- The corresponding turn indicator must be on when parking .

### 9.7. Operation

In principle there are two ways to activate the Parking Maneuvering Assistant:

#### Activation via parking assistance button

When the PMA is activated via the parking assistance button in the center console the parking assistance menu in the CID is displayed. As soon as a parking space is found, the driver receives handling instructions that guide him through the parking procedure with the support of the system. When parking automatically, the driver must press the parking assistance button until the parking procedure is complete.



Switch block with parking assistance button

# I01 Driver Assistance Systems

## 9. Parking Maneuvering Assistant

Index	Explanation
1	Parking assistance button

### Activation by "Engaging reverse gear" followed by "iDrive controller operation"

When the reverse gear is engaged, the parking assistance menu is displayed in the CID accompanied by the status of the parking space search. The PMA is however not yet activated. This is indicated by the PMA symbol in the symbol bar of the CID. In order to park supported by the system, the parking operation must be activated via the controller by selecting the corresponding symbol in the symbol bar at the CID. When parking automatically, the driver must press the parking assistance button until the parking procedure is complete.

### Park procedure

A checkmark then appears on the right below the PMA symbol in the CID to tell the driver that the PMA is active.



Parking procedure via PMA

If the PMA is activated during the journey via the PDC button, the driver is informed about the parking space search in the CID. If a parking space is found, this appears on the corresponding side in the CID. The driver is also at the same time instructed to stop the vehicle.



Parking procedure via PMA

The driver is instructed to confirm the parking space by pressing the turn indicator in the corresponding direction.

# I01 Driver Assistance Systems

## 9. Parking Maneuvering Assistant

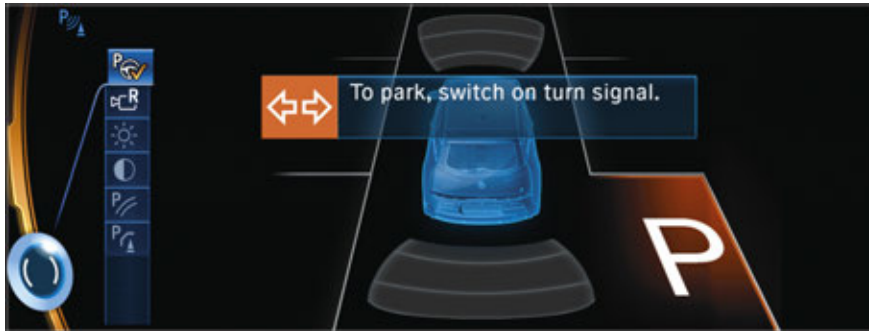

Parking procedure via PMA

The parking procedure can now be started by pressing the PDC button. The PDC button must be held pressed. The driver must then release the brake.



Parking procedure via PMA

Upon completion, an acoustic signal sounds and a confirmation message appears to tell the driver that the parking procedure is complete. The PMA engages P thus preventing the vehicle from rolling away.



Parking procedure via PMA

### Manual deactivation criteria

The Parking Maneuvering Assistant can be deactivated at any time if necessary by the driver via the controller by selecting the corresponding symbol in the symbol bar on the CID. Another way to deactivate the PMA is to release the parking assistance button in the switch block next to the iDrive controller.

If a fault develops, a Check Control message ("The PDC has malfunctioned. Have system checked.") is displayed in the CID.

# I01 Driver Assistance Systems

## 9. Parking Maneuvering Assistant

### Automatic deactivation criteria

The Parking Maneuvering Assistant is switched off automatically when the following events occur:

- the parking assistance button is released
- the driver holds on to the steering wheel or steers himself
- a gear is selected that does not correspond to the instruction on the Control Display
- when accelerating
- the automatic parking brake is secured
- the turn indicator opposite the required parking side is switched on
- at speeds above approx. 10 km/h / 6 mph
- possibly if the roadway is covered with snow or is slippery
- the tailgate is open
- possibly if the objects are difficult to overcome, e.g. parking curbs
- if obstructions suddenly appear
- a maximum number of parking maneuvers or parking duration has been exceeded.

### 9.8. System limits

The detection of objects can test the ultrasonic measurement system to its limits. Several examples of this are shown below:

- with trailer towbars and couplings
- if the objects are thin or wedge-shaped
- if the objects are projecting and elevated, e.g. wall projections or vehicle loads
- if the objects have corners and sharp edges
- if the objects have fine surfaces or structures, e.g. fences.

Low objects that are already displayed, e.g. curbs, may fall within the blind spot of the sensors before or after the point where a continuous alarm sounds. It would not be possible to detect objects that are higher up and project, e.g. wall projections. Parking spaces may be detected although these are not suitable.

Functional limitations are possible in the following situations, for example:

- if the sensors are dirty or iced up
- heavy fog, rain or snow
- on an uneven surface, e.g. gravel roads
- on a slippery surface
- on steep inclines or downhill gradients
- if leaves have gathered or snow has piled up in the parking space.



# I01 Driver Assistance Systems

## 9. Parking Maneuvering Assistant

To ensure the ultrasonic sensors remain fully operational, they must be kept clean and free of ice. When cleaning the sensors using a high pressure cleaner, avoid direct and sustained contact with a high-pressure water jet. Furthermore, when using high pressure cleaners, a distance of at least 30 cm from the sensors must be maintained.



---

The Parking Maneuvering Assistant (PMA) cannot replace the driver's personal judgement of the traffic situation. Also check the traffic situation by taking a look around the vehicle. Otherwise there is a risk of accidents occurring, due to other road users or objects that are outside the detection range of the Park Distance Control PDC for example. Loud sound sources outside and inside the vehicle may mask the acoustic signals of the PMA or the PDC.

---

# I01 Driver Assistance Systems

## 10. Cruise Control

### 10.1. Introduction

Two cruise control systems are available with the I01. The customer can choose between the standard equipment DCC cruise control with braking function and the optional equipment ACC Stop & Go + Active Driving Assistant which is included in the Technology + Driving Assistant Package (SA ZTD).



The speed control systems support the driver with adapting his speed, distance and driving style to the traffic conditions but do not relieve him of this responsibility. The driver may need to actively intervene, e.g. by braking, steering or taking evasive action, as otherwise there is a risk of an accident.

### 10.2. Cruise control with braking function

The cruise control with braking function is used in the I01 as standard equipment. The system is also referred to as "Dynamic Cruise Control" DCC. DCC supports the driver on roads with less traffic by keeping the speed constant irrespective of the rolling resistances (incline, vehicle load). In spite of the support, the driver remains responsible for control of the vehicle. It is possible to override the DCC function at any time by braking or accelerating the vehicle. It is operated via the left-hand switch block in the multifunction steering wheel. The current speed is saved by pressing the SET button. The speed is increased or reduced by 1 km/h / 1 mph by tapping the rocker switch. Each time the rocker switch is pressed beyond the pressure point, the speed increases or reduces by 10 km/h / 6 mph. The DCC maintains a selected speed constant from approx. 30 km/h / 18 mph. During downhill driving, the brake is activated if the vehicle's own deceleration is not enough to hold the preset speed.

The adjustment range for the set speed has been limited to max. 150 km/h / 93 mph.

When the ECO PRO or ECO PRO+ is activated, the cruise control is also set for a fuel-efficient driving style.

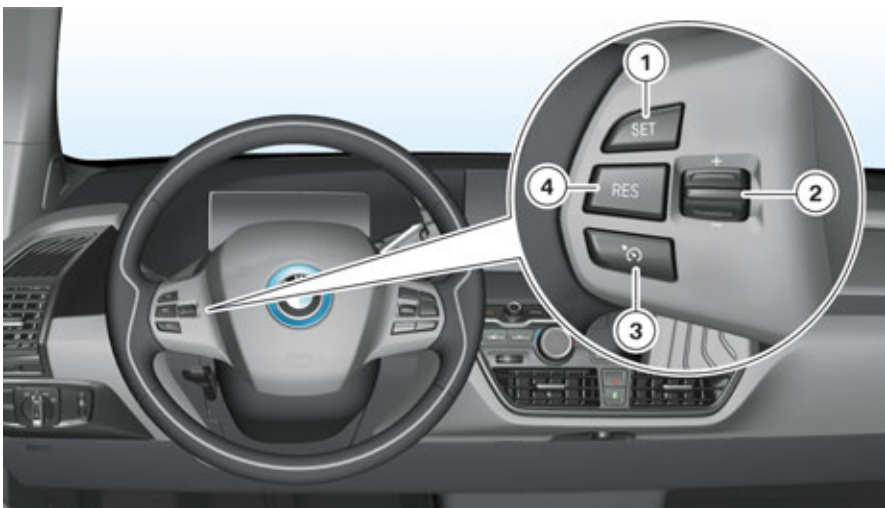

Buttons of the Dynamic Cruise Control (DCC)

# I01 Driver Assistance Systems

## 10. Cruise Control

Index	Explanation
1	Save speed button
2	Rocker switch for changing the set speed
3	Button for activating or deactivating the Dynamic Cruise Control (DCC)
4	RES button for calling up a saved set speed

In the I01, the control functions in different control units are calculated depending on the optional equipment used.

### Vehicles with DCC :

- The calculations are performed by the DSC control unit.
- In vehicles that are equipped with an optional equipment control unit (SAS) due to other optional equipment packages, the calculations are performed in the SAS.

## 10.3. Camera-based cruise control with Stop & Go + Active driving assistant function

### 10.3.1. Control functions

In the I01, the control functions in different control units are calculated depending on the optional equipment used.

### Vehicles with ACC Stop & Go + Active Driving Assistant (SA 5AT):

- The calculations are performed in the optional equipment control unit SAS.

### Cruise control

In principle, the cruise control in the ACC Stop & Go system works in exactly the same way as the Dynamic Cruise Control (DCC) system.

### Distance control (ranging)

The distance control is the core function of the ACC Stop & Go system. The driver can select a desired distance in four stages using two buttons on the multifunction steering wheel. ACC Stop & Go calculates the setpoint distance for the control from this preselection.

The setpoint distance during the journey is proportional to the driving speed. At a lower driving speed and at standstill, the proportional distance to the driving speed is no longer used for the ACC Stop & Go, but a fixed value in metres. The distance control uses the prepared object data with the highest diagnostic statistic as input variables. The distance control takes into consideration the following situations in particular:

- **Maximum values for acceleration and deceleration:**

# I01 Driver Assistance Systems

## 10. Cruise Control

The maximum values for acceleration and deceleration of the ACC Stop & Go system below approx. 50 km/h / 31 mph are dynamic values. They correspond to the acceleration values which the driver himself would use and considers comfortable. Depending on the situation, the ACC Stop & Go accelerates by a maximum of approx. 2 m/s<sup>2</sup> and decelerates by a maximum of approx. 4 m/s<sup>2</sup>.

- **Stop and start stability:**  
In the case of very heavy traffic and very low driving speed, the risk of rear-end collisions increases through heavy acceleration and braking. The ACC Stop & Go distance controller is therefore designed so that it decelerates as early as possible, but not stronger than the vehicle ahead. The system can decelerate by up to 2.5 m/s<sup>2</sup> at the most during subsequent operation, and by up to 4 m/s<sup>2</sup> at the most when stopping.

### Road speed control when cornering

The cruise control of the ACC Stop & Go on bends is based on the control characteristics of the Dynamic Cruise Control DCC. If an object is lost on bends, the system waits to see whether the object reappears (transition curve). The vehicle only accelerates if it does not reappear or the KAFAS camera no longer detects an object. Tight bends are detected via the data of the Dynamic Stability Control system DSC and the navigation system and the speed adjusted if necessary.

### 10.3.2. Operation

#### Activation and deactivation

The activation and deactivation of the ACC Stop & Go and the Dynamic Cruise Control are almost the same. ACC Stop & Go cannot only be activated by the driver during the trip, but also when the vehicle is at a standstill, if the system detected another vehicle before its own vehicle. To activate ACC Stop & Go at standstill, the driver must press the brake pedal and at the same time press the SET or RES button.

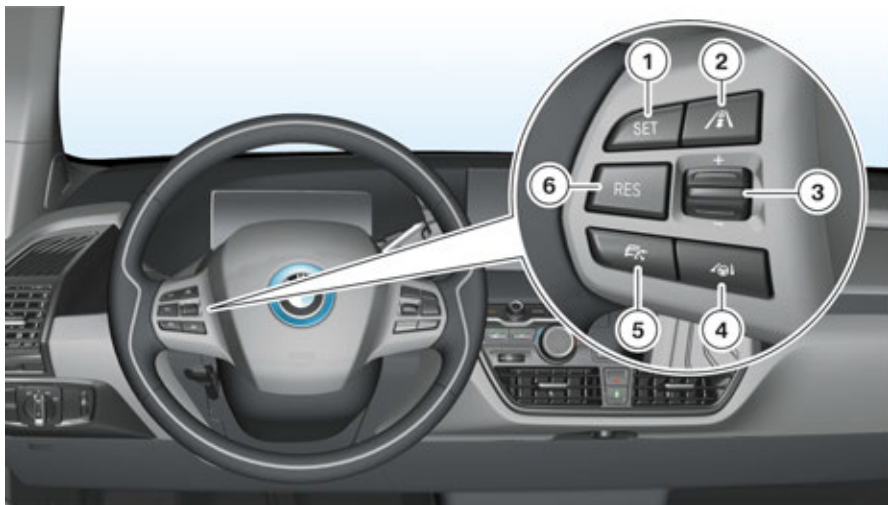

Buttons for ACC Stop & Go with traffic jam assistant button

# I01 Driver Assistance Systems

## 10. Cruise Control

Index	Explanation
1	Save speed button
2	Button for adjusting the distance
3	Rocker switch for changing the set speed
4	Button for activating or deactivating the traffic jam assistant (not for US)
5	Button for activating or deactivating ACC Stop & Go
6	RES button for calling up a saved set speed

### The following conditions must also be satisfied for activation:

- Seat belt fastened and doors closed
- Drive position D engaged
- Engine running
- Parking brake not activated
- Camera for ACC Stop & Go operational
- No system faults detected.

### Display



Display lights up green:  
System is active.



Display lights up orange:  
System has been interrupted.



Chosen set speed:  
The set speed is displayed next to the symbol in the KOMBI of the instrument cluster.



Distance control (ranging) active:  
ACC Stop & Go controls with reference to the distance set.

# I01 Driver Assistance Systems

## 10. Cruise Control



Vehicle symbol lights up orange:  
Vehicle driving ahead detected.



Vehicle symbol flashes orange:  
The prerequisites for operation of the system are no longer satisfied.  
The system has been deactivated, but brakes until the driver actively takes over by pressing the brake or the accelerator pedal.



Vehicle symbol flashes red and a signal sounds:  
The driver is prompted to intervene by braking and, if necessary, taking evasive action.



Distance control on standby:  
The accelerator pedal was pressed by the driver and a vehicle driving ahead is not detected.



Distance control on standby:  
The accelerator pedal was pressed by the driver and a vehicle driving ahead is detected.



Flashing bar:  
Detected vehicle has driven off.



Changing between cruise control with or without distance control:  
Cruise control without distance control.



Changing between cruise control with or without distance control:  
Cruise control with distance control.

# I01 Driver Assistance Systems

## 10. Cruise Control

### 10.3.3. System wiring diagram

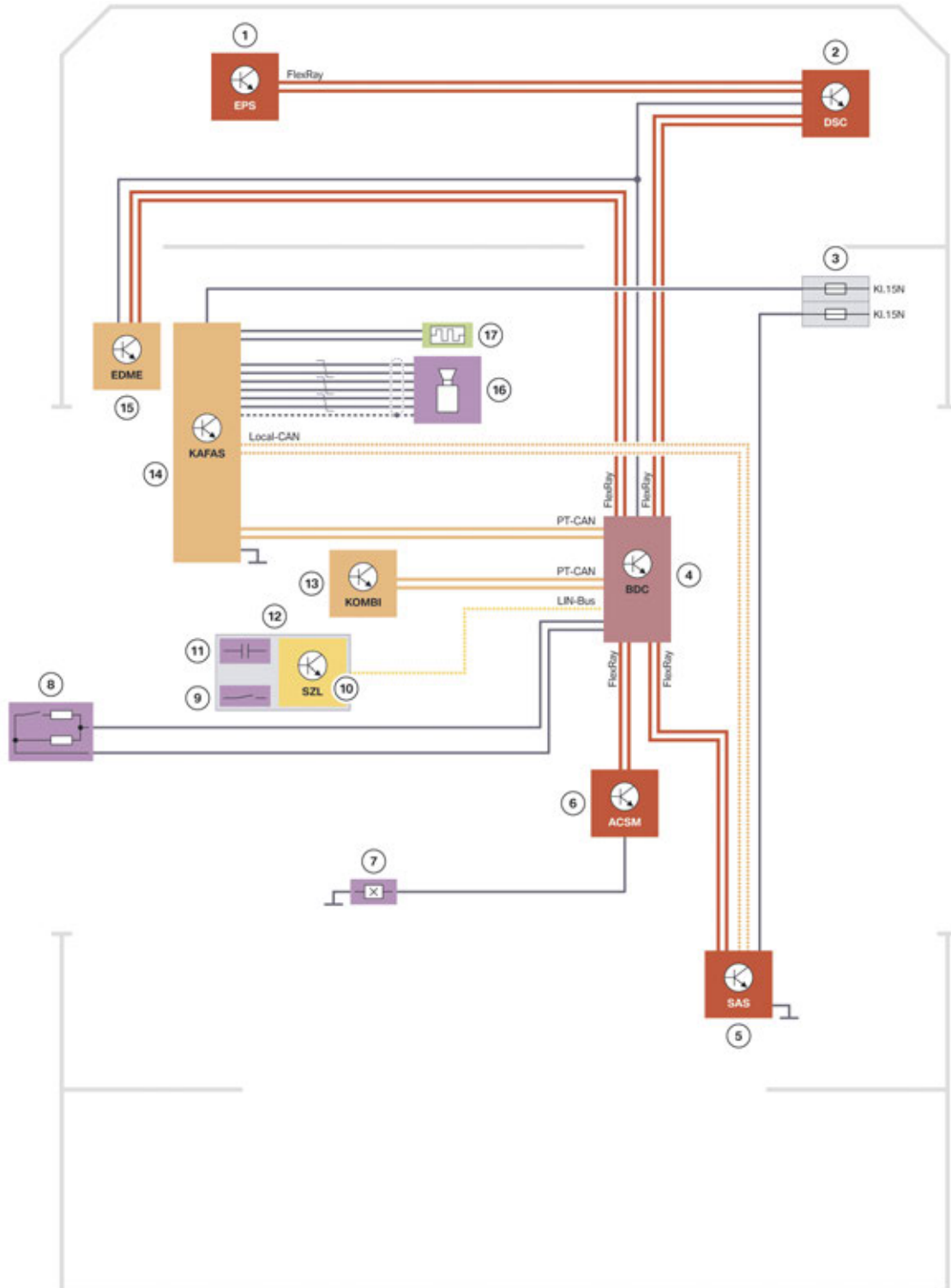

System wiring diagram, camera-based cruise control with traffic jam assistant

TE13-0402

# I01 Driver Assistance Systems

## 10. Cruise Control

<b>Index</b>	<b>Explanation</b>
1	Electromechanical Power Steering
2	Dynamic Stability Control
3	Fuses
4	Body Domain Controller
5	Optional equipment system (SAS)
6	Crash Safety Module
7	Seat belt buckle recognition, driver
8	Door contact, driver
9	Operating unit buttons for ACC Stop & Go
10	Steering column switch cluster
11	Hands-off Detection
12	Steering wheel with capacitive sensor (Hands-off Detection sensor)
13	Instrument cluster
14	KAFAS control unit
15	Electrical Digital Motor Electronics
16	KAFAS camera
17	Heating KAFAS camera







Bayerische Motorenwerke Aktiengesellschaft  
Qualifizierung und Training  
Röntgenstraße 7  
85716 Unterschleißheim, Germany